

Strong Three-point Magnet Antenna Base

K3000

(Tile angle structure magnet base / Usable with K9000)

Operation Instructions

To use this product properly, read this instruction thoroughly before using it. Keep this instruction carefully at hand for later use.

•Before using

K3000 is a magnet antenna base. To prevent any accident, pay attentions to the following instructions.

- ① Don't use the antenna exceeding the specified length and weight.
- ② Remove the antenna when there are obstacles such as braches.
- ③ Drive a car at less than 100km/h. When a head wind, speed down or remove the antenna.
- ④ Don't insert anything between the magnet antenna base and the car body
- ⑤ Don't install the magnet antenna base on the curved places.
- ⑥ Clean up the place where is installed.
- ⑦ Install the magnet antenna base only on the iron surface.

•How to install

- ① Insert the connector section of the cable set (not included) into $\phi 16$ hole of the center of the trigon from beneath and fix it with the hexagonal nut etc.
- ② Loosen the hexagonal cap nuts (M8) fixing the trigon and the magnet base and fasten those nuts lightly by hand as the magnet base can be moved with ease.
- ③ Install the K3000 on the car body slowly and fix it.
- ④ Confirm and adjust as there is no space between the under surface of the antenna base and the car body. Fasten the hexagonal cap nuts by the spanner.
- ⑤ Be careful not to introduce the rain water into the car through the cable. (Fix only magnet base on the car body.)
- ⑥ When removing the magnet base, remove three hexagonal cap nuts, spring washers and the tilt angle clasps and also take off the trigon.
- ⑦ Screw the desorption attachment in the thread part of the upper surface of the antenna base and fix it. Pull the desorption attachment down to the side and remove the antenna base. If sliding it from side to side, the surface will be damaged.
- ⑧ When removing the antenna from the K3000, cover the connector parts with the attached water proof cap.

•Usable antenna specification

Length: Less than 1.7m

Weight: Less than 1.0kg (If the antennas have the loading coils, the coils should be in the lower parts.)

•Parts description (number)

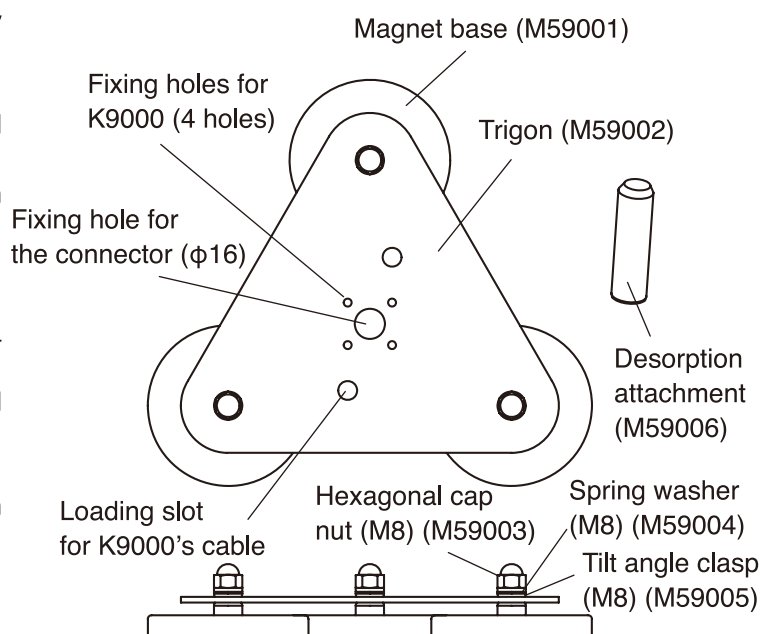

※ How to fix K9000

Inset the cable from the lower part of K9000 into the loading slot of the trigon. Set K9000 on the trigon and fix it with four set screws (including K9000). Use one of the loading slots depending on the installation place.

■ Though the product being purchased is manufactured under strict quality control, if damage is caused by transporting, ask your dealer promptly.

■ Design and specification of these products will be changed for future improvement without advance notice.